

# MIPRO®

## MES-100 WebMote Bridge Server User Guide





## Contents

- 1 Part Names
- 2 Operation
- 5 System Configurations
- 6 LCD Screen
- 12 Cautions

## I. Part Names, Fig. 1

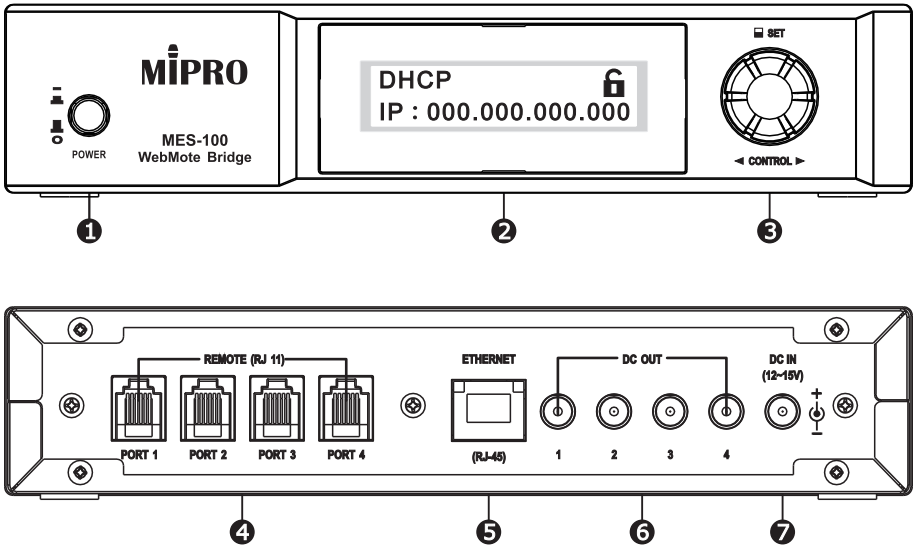
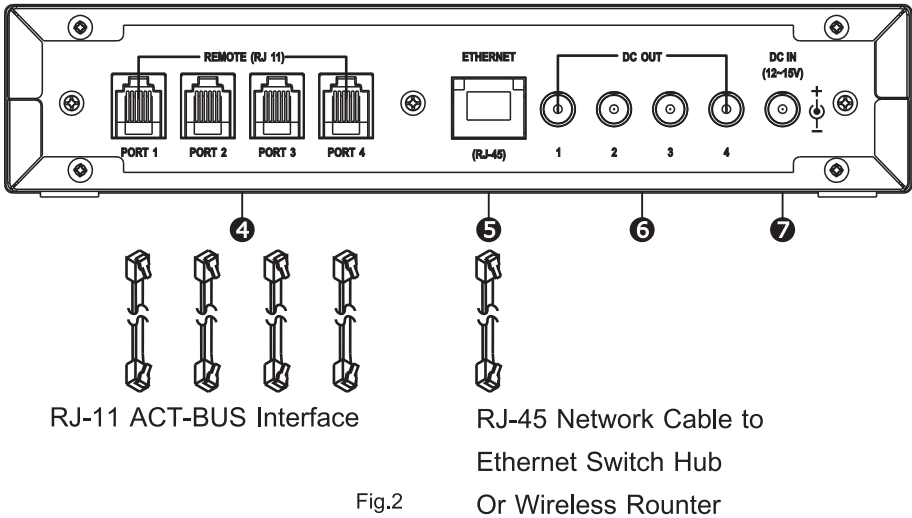

Fig.1

- ❶ Power Switch
- ❷ LCD Screen
- ❸ Rotary Control Knob
- ❹ RJ-11 Ports (Port1~Port4): ACT-BUS ports
- ❺ Ethernet 10/100Mbps RJ-45 Port
- ❻ DC-Output Jack (12V/0.5A DC-OUTPUT1~4)
- ❼ DC-Input Jack: Central electrode must be connected to positive electricity

## II. Operation, Fig.2



### 1. To improve the transmission efficiency of ACT-BUS:

Since Ethernet cable provides a 100 Mbps data transfer rate, nearly 1,000 times faster than the ACT-BUS of 110 Kbps, the MES-100 uses four RJ-11 Ethernet interfaces to split the high-speed bandwidth to improve the speed of ACT-BUS devices. In the past, one RJ-11 bandwidth of 110 Kbps had to be shared by 64 devices. Now, because the MES-100 provides four parallel RJ-11 ACT-BUS interfaces, the bandwidth is shared by only 16 devices and data transmission efficiency improves dramatically.

## 2. WebMote® Interface (Software Installation is Not Required):

- (A) WebMote® (Web Remote Control Interface) is an interface provided by the MES-100 bridge server for remote monitoring. The interface shows a variety of MIPRO systems to choose from: Simply click on the appropriate receiver and the MES-100 will search the device connected to the RJ-11 socket and then lock onto its panel, allowing the user to monitor the status or change the parameters on the monitoring page.
- (B) The WebMote monitoring page is written in HTML5. Since browsers today can be compatible with any operating system, the user is able to connect to WebMote through the web to monitor any MIPRO products which are connected to the MES-100. In addition, since the WebMote monitoring page exists in the MES-100 bridge server, users don't have to pre-install any software, no matter whether they are using smart phones, tablets or computers. Internet accessibility is the only requirement.

## 3. Wireless Remote Control via Wi-Fi:

In addition to wired access, the MES-100 provides Ethernet, which can be connected to the switch hub as a wireless base station, thus allowing the users to wirelessly access the device through Wi-Fi.

#### 4. Power Installation:

Connect the output end of a DC 12V~15V switching power to the DC Input Jack of MES-100, then plug the other end into an AC outlet as shown in Fig. 3.

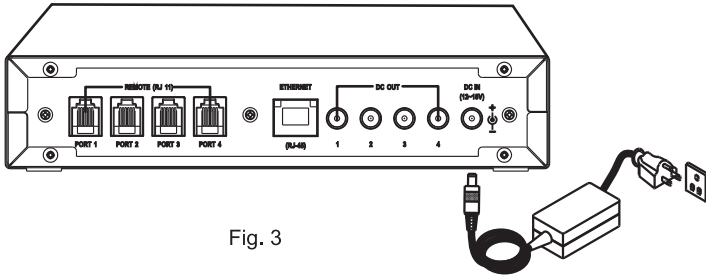

Fig. 3

#### 5. Power On, Fig. 4:

Press power switch ❶ to ON, LCD screen ❷ is lit with various system information after a few seconds.

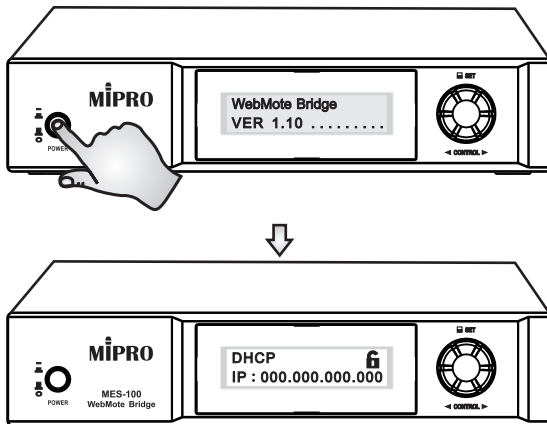

Fig. 5

### III. System Configurations, Fig. 5

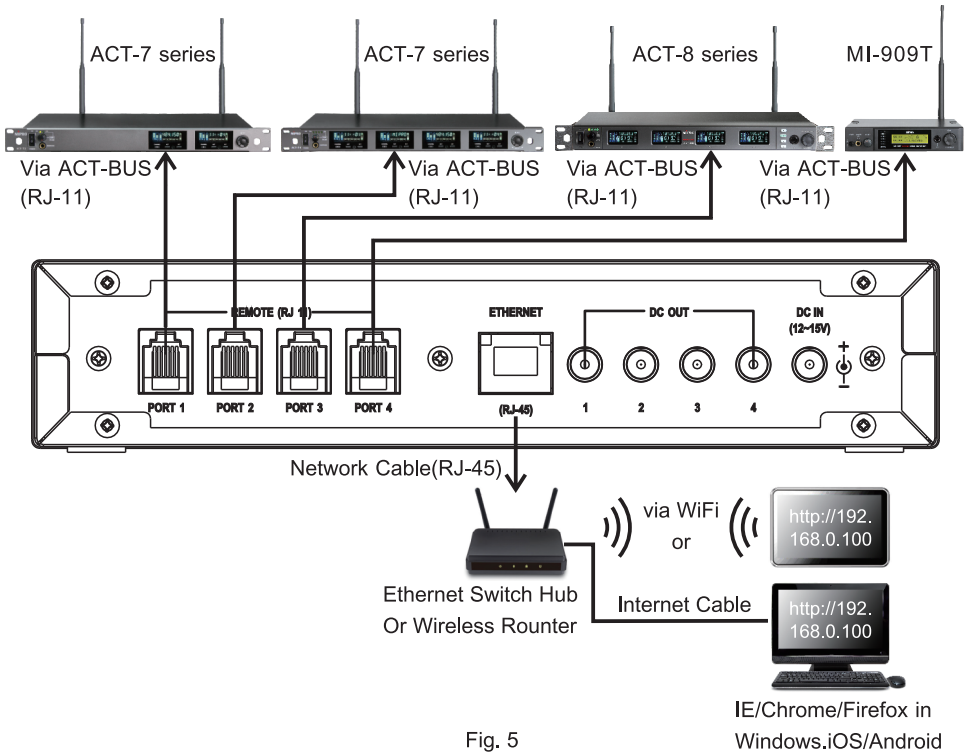

Fig. 5

#### Attention:

- PORT 1: To connect equipment with ACT-BUS address of 1, 5, 9,..., 61
- PORT 2: To connect equipment with ACT-BUS address of 2, 6, 10,..., 62
- PORT 3: To connect equipment with ACT-BUS address of 3, 7, 11,..., 63
- PORT 4: To connect equipment with ACT-BUS address of 4, 8, 12,..., 64



## IV. LCD Screen

### 1. Displays functions and parameters, Fig. 6

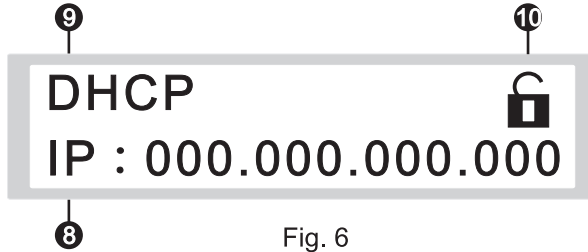

Fig. 6

- ⑧ Current IP Address
- ⑨ IP Assigning Mode (DHCP or STATIC IP)
- ⑩ Screen Lock Indicator

### 2. Turns the Rotary Control Knob to enter parameter setup menu, Fig. 7.

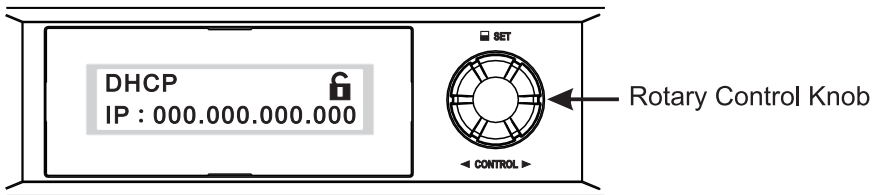
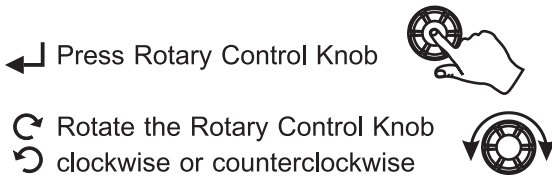

Fig. 7

- (A) Press rotary control knob ③ to enter the main function screen.
- (B) Rotate the rotary control knob clockwise or counterclockwise to control " > " to select the desired setting item, then press the rotary control knob to enter setting status. After completion of setting, press the rotary control knob again to save the new parameters and return back to main screen.

(C) How to Operate Rotary Control Knob



3. Operation of Main Functions, Fig. 8

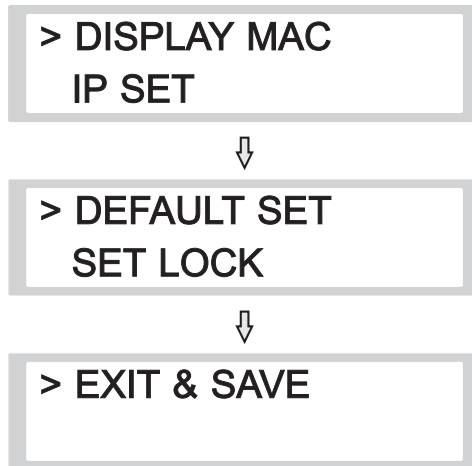

Fig. 8

(A) DISPLAY MAC Operation, Fig. 9



Fig. 9

- (1) Rotate the rotary control knob to "DISPLAY MAC" and press the knob again to how MAC address of MES-100. MAC address is different from different MES-100.
- (2) Press the rotary control knob again to return to the main screen.

## (B) IP SET Operation, Fig. 10:

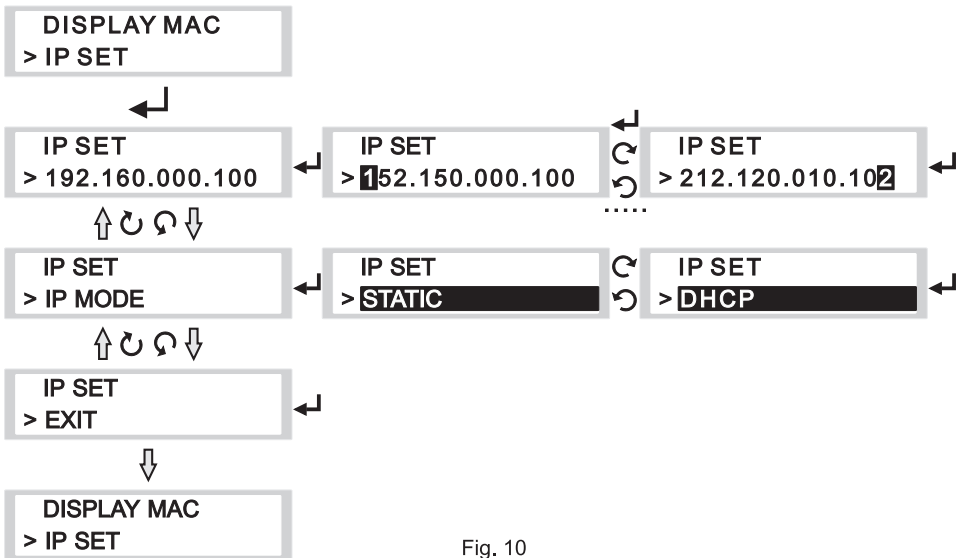

Fig. 10

- (1) Rotate the rotary control knob to IP SET and press knob again to enter. Once entered, rotate to the desired parameter and push button again to highlight.
- (2) When rotating the rotary control knob clockwise, the parameters of IP SET will be moved by IP Address IP MODE EXT. When rotating the rotary control knob counterclockwise, the parameters of IP SET will be moved by EXIT IP MODE IP Address.
  - (a) IP Address: Rotate the rotary control knob to change and setup each digit of STATIC IP address.
  - (b) IP MODE: Rotate the rotary control knob to IP SET and press knob again to enter. Once entered and highlighted, choose between STATIC and DHCP.
    - (i) Choose STATIC: IP address requires manual setup. Press knob again to return to IP SET.
    - (ii) Choose DHCP: IP address sets up automatically
  - (c) EXIT: Once completed setup, select EXIT and press knob to leave the setup page and return to the main page.

(C) DEFAULT SET Operation, Fig.11:



Fig. 11

- (1) Rotate the rotary control knob to DEFAULT SET and press knob again to enter.
- (2) Once entered and highlighted, choose between RESET? and EXIT.
  - (a) Choose RESET?: MES-100 return to factory default setting after pressing knob and confirm.
  - (b) Choose EXIT: All parameters remain unchanged and system return to main screen.
- (3) Press the rotary control knob again to return back to main screen.

(D) SET LOCK  : Lock and Unlock Panel, Fig. 12

Fig. 12



- (1) Rotate the rotary control knob to select “SET LOCK” then press the knob to enter.
- (2) Rotate the rotary control knob clockwise or counterclockwise to switch between highlighted UNLOCK and LOCK.
  - (a) When “UNLCOK”, it means release lock and “” appears.
  - (b) When “LOCK”, it means panel is locked and “” appears.
- (3) Press the rotary control knob again to return back to the main function screen.
- (4) When  appears, it means the panel is locked and cannot operate any function to prevent MES-100 from accidental operation. It is necessary to release the lock of panel before setting new parameters. Fig.13

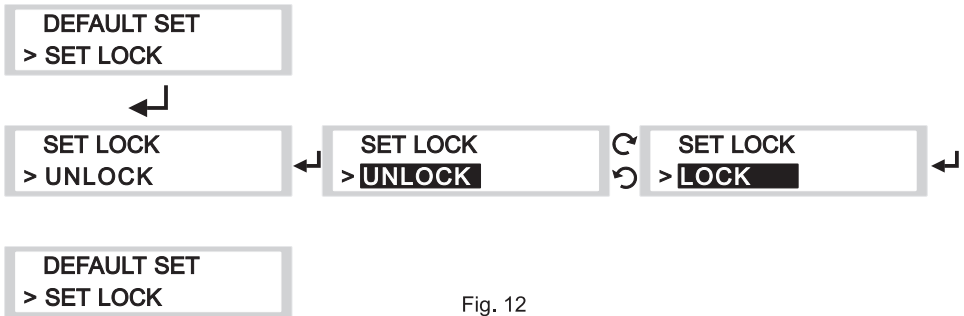

Fig. 13

(E) EXIT & SAVE:



Fig. 14

Select EXIT & SAVE and press the rotary control knob to leave the setting of parameters and return back to main screen and all the new parameters will be saved automatically. Fig.14

## V. Cautions

1. The required power supply should be between 12V ~ 15V and at least 500mA electric current. (Pay attention to the limit of electric current if needed to provide power to other equipment via DC OUT). Insufficient power supply will cause the unstable operation or malfunction of MES-100. Exceeding power supply will make the MES-100 overheated and shorten its life or even make it burnt.
2. Each DC OUT can only provide maximum current of 0.5A, please do not connect to other equipment those power consumption are uncertain.
3. As MES-100 is capable of providing power to other equipment, please calculate first if input current for MES-100 is sufficient to supply itself and other equipment. Insufficient current can cause malfunction of MES-100 or other connecting equipment.
4. When remotely control MES-100, different hardware (mobile phone, tablet PC, or Wi-Fi station) could possibly cause different speed on updating the data or unstable connection.
5. Refer to actual product in the event of product description discrepancy.

## Federal Communication Commission Interference Statement

This equipment has been tested and found to comply with the limits for a Class B digital device, pursuant to Part 15 of the FCC Rules. These limits are designed to provide reasonable protection against harmful interference in a residential installation. This equipment generates, uses and can radiate radio frequency energy and, if not installed and used in accordance with the instructions, may cause harmful interference to radio communications. However, there is no guarantee that interference will not occur in a particular installation. If this equipment does cause harmful interference to radio or television reception, which can be determined by turning the equipment off and on, the user is encouraged to try to correct the interference by one of the following measures:

- ! Reorient or relocate the receiving antenna.
- ! Increase the separation between the equipment and receiver.
- ! Connect the equipment into an outlet on a circuit different from that to which the receiver is connected.
- ! Consult the dealer or an experienced radio/TV technician for help.

FCC Caution: To assure continued compliance, any changes or modifications not expressly approved by the party responsible for compliance could void the user's authority to operate this equipment. (Example - use only shielded interface cables when connecting to computer or peripheral devices).

## FCC Radiation Exposure Statement

This equipment complies with FCC RF radiation exposure limits set forth for an uncontrolled environment. This equipment should be installed and operated with a minimum distance of 0.5 cm between the radiator and your body.

This transmitter must not be co-located or operating in conjunction with any other antenna or transmitter.

The antennas used for this transmitter must be installed to provide a separation distance of at least 0.5 cm from all persons and must not be co-located or operating in conjunction with any other antenna or transmitter.

This device complies with Part 15 of the FCC Rules. Operation is subject to the following two conditions: (1) This device may not cause harmful interference, and (2) This device must accept any interference received, including interference that may cause undesired operation.



## WARNING

### 1. FOR OUTDOOR USE:

To reduce the risk of fire or electric shock, do not expose this apparatus to rain or moisture.

### 2. UNDER WET LOCATION:

Apparatus should not be exposed to dripping or splashing and no objects filled with liquids, such as vases should be placed on the apparatus.

### 3. SERVICE INSTRUCTIONS:

**CAUTION** - These servicing instructions are for use by qualified service personnel only. To reduce the risk of electric shock, do not perform any servicing other than that contained in the operating instructions unless you are qualified to do so.



 This symbol indicates that dangerous voltage constituting a risk of electric shock is present within this unit.

 This symbol indicates that there are important operating and maintenance instructions in the literature accompanying this unit.

**Disposal** Dispose of any unusable devices or batteries responsibly and in accordance with any applicable regulations.



Disposing of used batteries with domestic waste is to be avoided!

Batteries / NiCad cells often contain heavy metals such as cadmium(Cd), mercury(Hg) and lead(Pb) that makes them unsuitable for disposal with domestic waste. You may return spent batteries/ accumulators free of charge to recycling centres or anywhere else batteries/accumulators are sold.

**2005-08-13**

By doing so, you contribute to the conservation of our environment!

## IC

This device complies with Industry Canada licence-exempt RSS-123 ISSUE 2 / RSS-310 ISSUE 3 standards. Operation is subject to the following two conditions:

- (1) this device may not cause interference, and
- (2) this device must accept any interference, including interference that may cause undesired operation of the device.

Le présent appareil est conforme aux CNR d'Industrie Canada applicables aux appareils radio exempts de licence. L'exploitation est autorisée aux deux conditions suivantes :

- (1) l'appareil ne doit pas produire de brouillage, et
- (2) l'utilisateur de l'appareil doit accepter tout brouillage radioélectrique subi, même si le brouillage est susceptible d'en compromettre le fonctionnement.

## ! IMPORTANT SAFETY INSTRUCTIONS !

1. Read these instructions.
2. Keep these instructions.
3. Heed **all** warnings.
4. Follow **all** instructions.
5. Do not use this apparatus near water.
6. Clean only with a dry cloth.
7. Do not block any ventilation openings. Install in accordance with the manufacturer's instructions.
8. Do not install near any heat sources such as radiators, heat registers, stoves, or other apparatus (including amplifiers) that produce heat.
9. Do not defeat the safety purpose of the polarised or ground plug: A polarised plug has two blades with one wider than the other. The wide blade is provided for your safety. When the provided plug does not fit into your outlet, consult an electrician for replacement of the obsolete outlet.
10. Protect the power cord from being walked on or pinched particularly at plug, convenience receptacles, and the point where they exit from the apparatus.
11. Only use attachments/accessories specified by the manufacturer.
12. Use only with a cart, stand, tripod, bracket, or table specified by the manufacturer, or sold with the apparatus. When a cart is used, use caution when moving the cart/apparatus combination to avoid injury from tip-over.
13. Unplug this apparatus during lightning storms or when unused for long periods of time.
14. Refer **all** servicing to qualified service personnel. Servicing is required when the apparatus has been damaged in any way, such as power-supply cord or plug is damaged, liquid has been spilled or objects have fallen into the apparatus, the apparatus has been exposed to rain or moisture, does not operate normally, or has been dropped.
15. To reduce the risk of fire or electric shock, do not expose this apparatus to rain or moisture.
16. Apparatus should not be exposed to dripping or splashing and no objects filled with liquids, should be placed on the apparatus.
17. Use only with the battery which specified by manufacturer.
18. The power supply cord set is to be the main disconnected device.





**MIPRO**<sup>®</sup>  
MICROPHONE PROFESSIONALS

**MIPRO Electronics Co., Ltd**

Headquarters: No. 814, Beigang Rd., Chiayi City 600096, Taiwan  
Tel : +886.5.238.0809  
www.mipro.com.tw

Fax : +886.5.238.0803  
mipro@mipro.com.tw



All rights reserved. YM 020/04

Do not copy or forward without prior approvals MIPRO.

Specifications and design subject to change without notice.



2 CE527A